

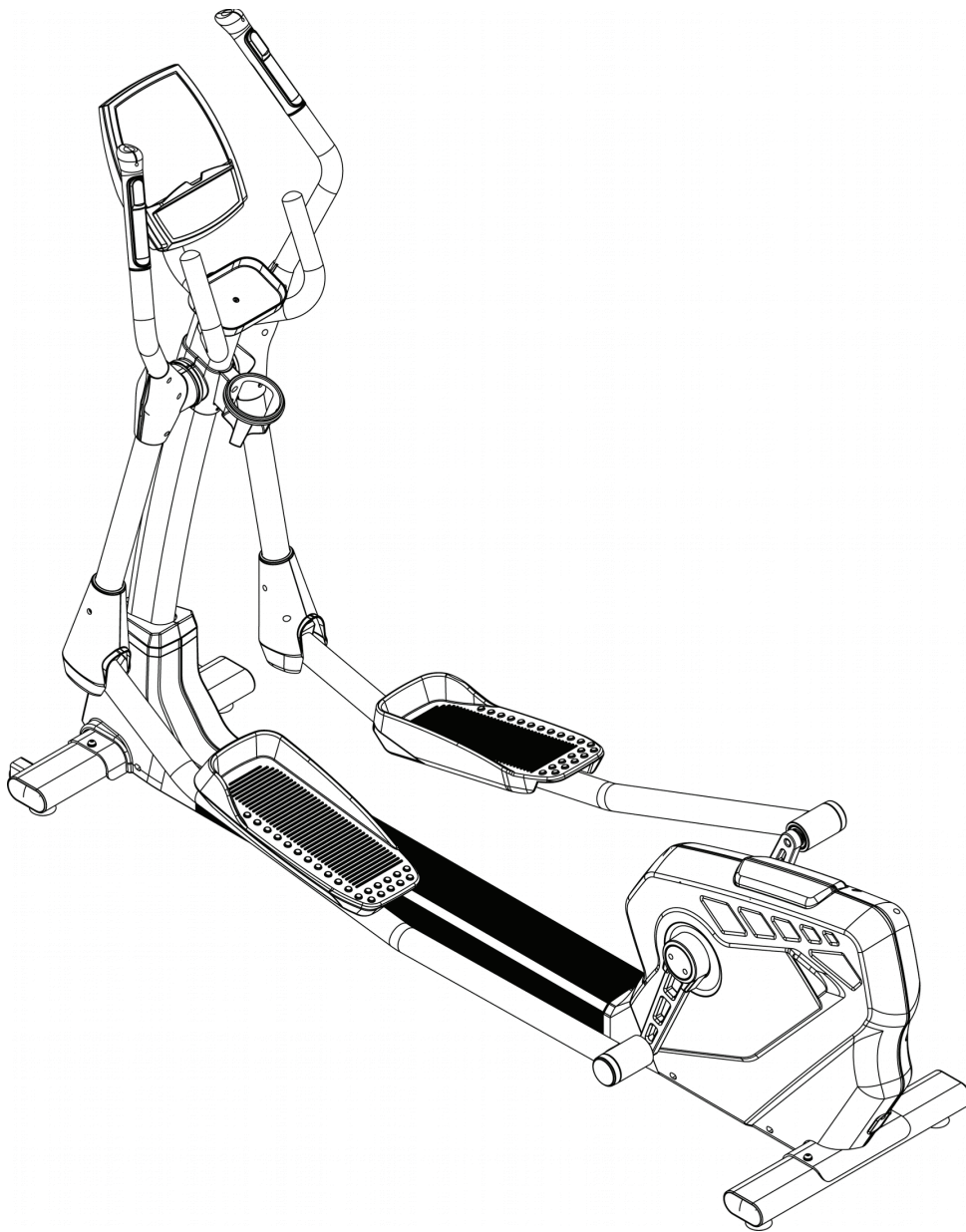

hattrick-pro

T-1000 COMMERCIAL ELLIPTICAL BIKE



Cardio Series

User Manual

English

Before You Start

Thank you for purchasing this exercise bicycle! This quality product you have chosen was designed to meet your needs for cardiovascular exercise.

Prior to assembly, remove components from the box and verify that all the listed parts were supplied. Assembly instructions are described in the following steps and illustrations.

SAFETY INSTRUCTION

When using this product, basic precautions should always be followed, including the following:

Please read the instruction carefully before starting to use this product:

DANGER – To reduce the risk of electric shock:

Always unplug this product from the electrical outlet immediately after using and before cleaning.

WARNING – To reduce the risk of burns, fire, electric shock, or physical injury:

1. When this product insert the plug, please attention on it's condition to avoid being in dangerous.
2. Before you use this machine, please step on it first, then start the machine, please do not do this on the contrary.

When the machine without using or you are wearing or taking off your cloth, please take off the plug first.

3. To avoid any danger, close supervision is necessary when this production is used by children, invalids or disabled persons.

4. The one whose body, sense or mind (include children) or someone less experience and knowledge can not use this machine unless under supervising. Children can not use the machine.

5. Un-correct or exceeding training maybe cause danger to your health.

6. Be sure to use the product only for its intended use as described in this manual. Do not use any attachment not recommended by the manufacturer in order to avoid any danger or accidents.

7. Never operate the product if it has a damaged cord or plug, if it is not working properly, if it has been damaged, or dropped into water. Please return the product to the service center of seller for examination and repair.

8. Do not carry this product by the supply cord or use the cord as a handle.

9. Keep the cord away from hot surfaces or ground.

10. Never operate the product with the air vents blocked. Keep the air vents free of lint, hair, etc.

11. Never drop or insert any objects into any vent of the product.

12. Do not use or operate outdoors.

13. Please put this product on flat surface or platform.

14. Keep a 100cm safety area around the machine.

15. Do not operate where aerosol (spray) products are being used or where oxygen is thin.

16. Before turning the product power off, turn all controls to the off position then remove the plug from the outlet.

17. Connect the product to a properly grounded outlet only.

18. 19. This product only can be used for commercial.

19. Please check the machine regularly to confirm if it is damaged or not, then you can keep it safety.

20. Brake system is controlled by the speed under watts mode, but under other mode, it not depends on speed.

“ **WARNING!** ” Heart rate monitoring systems may be inaccurate. Over exercising may result in serious injury or death. If you feel faint stop exercising immediately.

Important Safety Information **WARNING!**

- 1) Before using this exercise bicycle or starting any exercise program, consult your physician. This is especially important for persons over the 35 and /or persons with pre-existing health problems. Our company assumes no responsibility for personal injury or property damage sustained by or through the use of this product.

- 2) To reduce the risk of electrical shock, burns, fire or other possible injuries to the user, it is important to review this manual and the following precautions before operation.

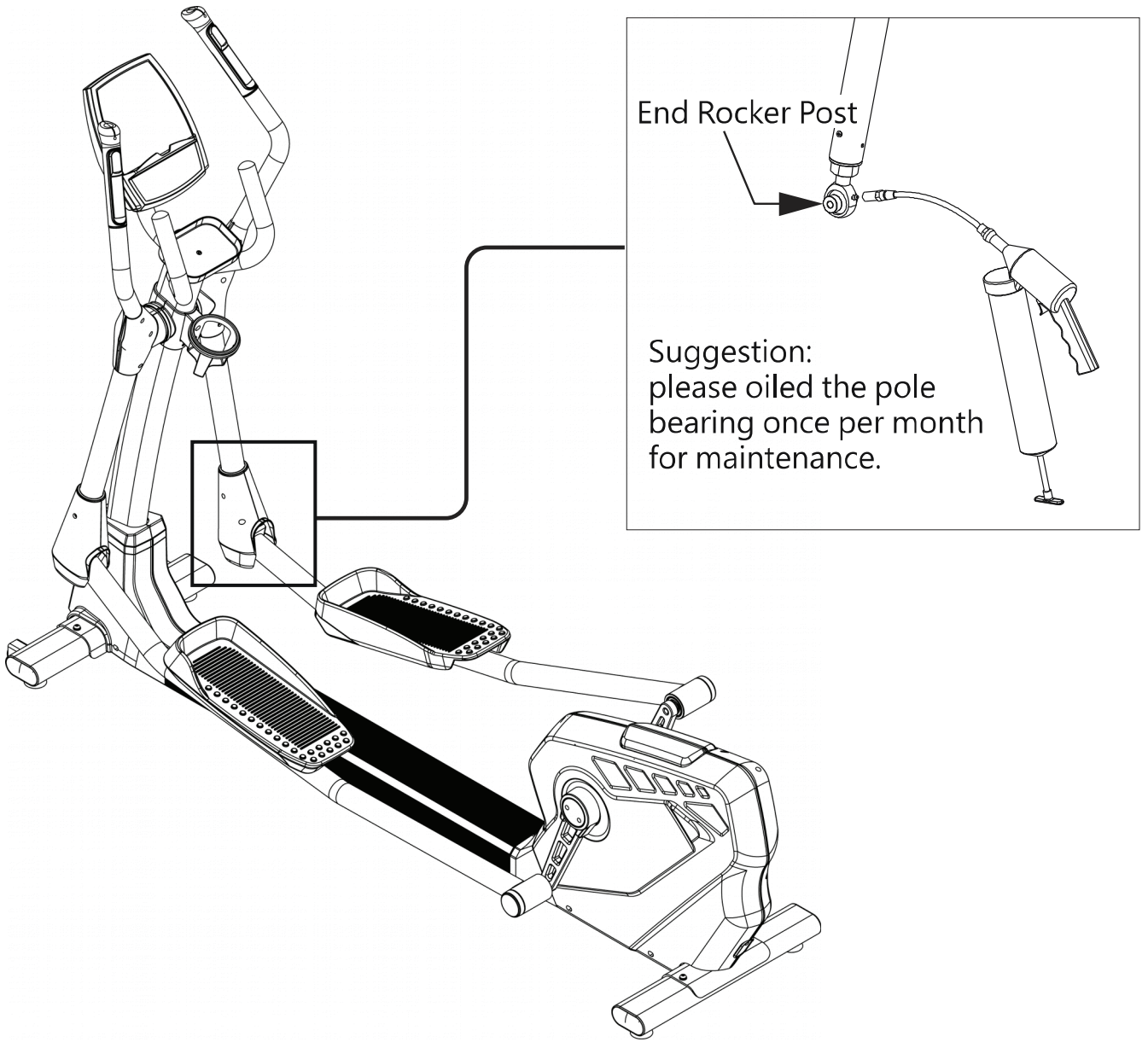

Part Details

A. Control tube set

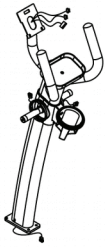

B. Main frame set

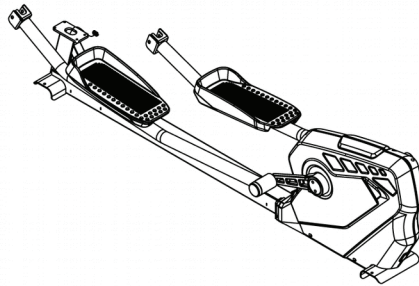

C. Front stabilizer set



D. Rear stabilizer set

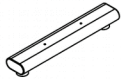

E. Swing tube set (left)



F. Swing tube set (right)



G. Main frame front cover (left) (right)

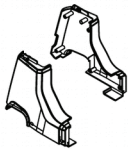

H. Control tube decoration cover (left) (right)



I. Swing tube shaft decoration cover (left front) (left rear)



J. Computer console set (LED)



K. Swing tube shaft decoration cover (right front) (left rear)



L. Swing tube lower decoration cover (left external) (left internal)



M. Swing tube lower decoration cover (right external) (right internal)



P. Middle cover

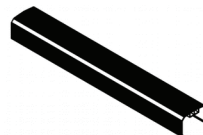

Screw bag

ITME	Description	Qty	ITEM	Description	Qty
K01	Truss inner hex screw M8xP1.25x25	4	K12	Nylon nut M10xP1.5	2
K02	Spring washer M8	4	K13	Truss cross screw M4xP0.7x12	16
K03	Washer $\Phi 8 \times \Phi 16 \times 1.5t$	4	K14	Truss cross self-taping screw $\Phi 4 \times 16$	16
K04	CKS inner hex steel screw M8xP1.25x20	4	K20	Truss cross screw M5xP0.8x12	2
K05	Washer $\varnothing 8 \times \varnothing 12 \times 1.0t$	4	K21	L-shaped hex wrench + cross opener 5mm	1
K06	Wave washer $\varnothing 25.6 \times \varnothing 33.7 \times 0.3t$	2	K22	Opening wrench 13mm+15mm	1
K07	Allen steel screw M10xP1.5x15	2	K23	L-shaped hex wrench + cross opener 6mm	1
K08	Spring washer M10	2	K24	Torx-shaped wrench '9211	1
K09	Washer $\varnothing 10 \times \varnothing 30 \times 2.0t$	2	K25	Bushing wrench + cross opener 13mm+17mm	1
K10	Allen steel screw M10xP1.5x75	2			
K11	Flat washer $\Phi 10 \times \Phi 20 \times 2.0t$	4			

K01.



K02.



K03.



K04.



K05.



K06.



K07.



K08.



K09.



K10.

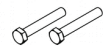

K11.



K12.



K13.



K14.



K20.



K21.



K22.



K23.



K24.



K25.



Maintenance:
Please charge the battery per month.

Installation steps

Step 1:

Ana çerçeve setini (B) ve ön ve arka sabitleyici setini (C, D) vidayla (K01) ve yaylı rondelayı (K02), pulu (K03) kullanarak sabitleyin

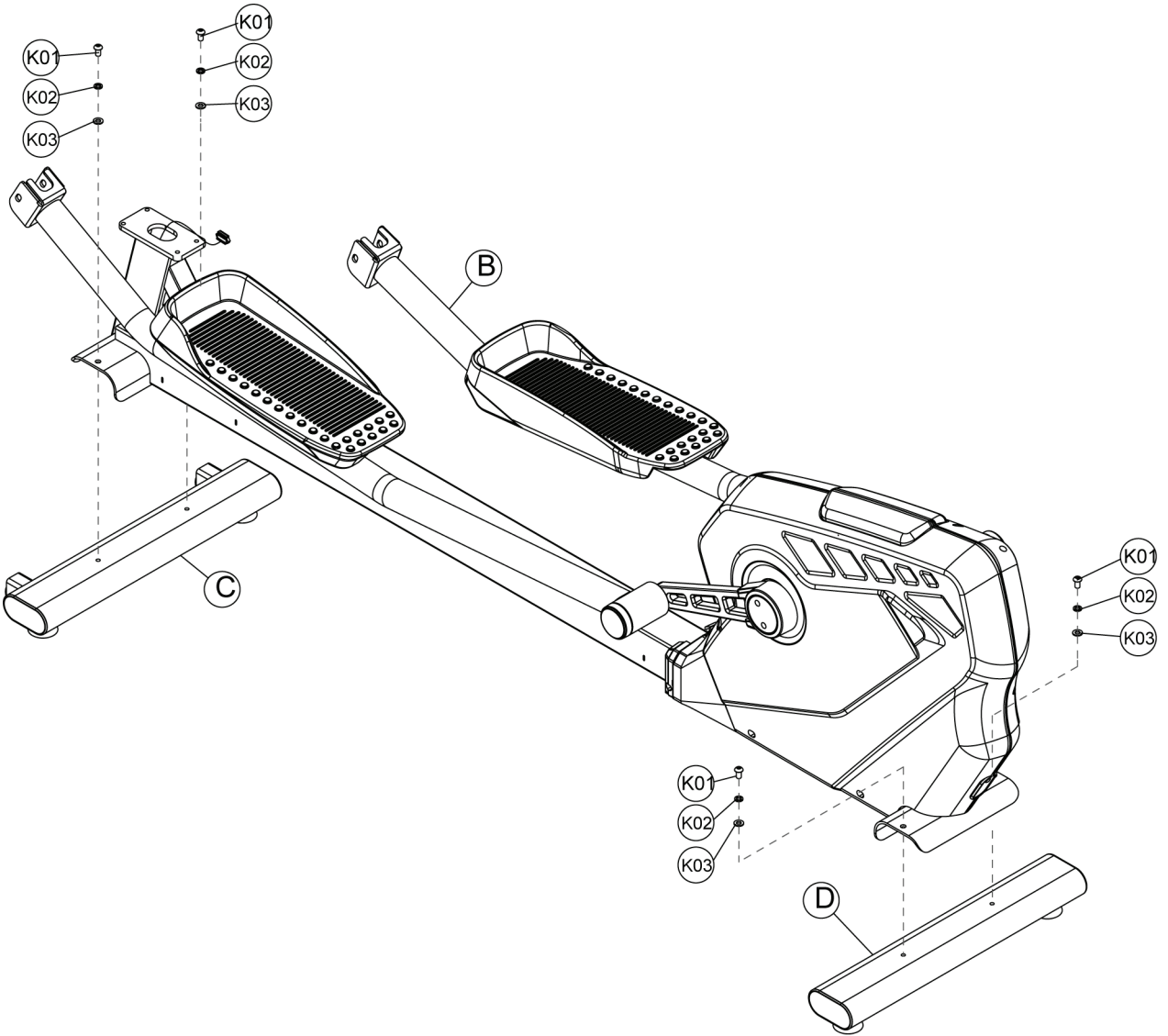

Step 2:

Connect the relative wires abiding by the image, and assemble the control tube set (A) to the main frame set (A) with screw (K04), washer (K05).

Next, fix the main frame front cover (G) to the main frame with screw (K14), and then fasten the control tube decoration cover (H) with screw (K14). Finally, cover with the middle cover (P).

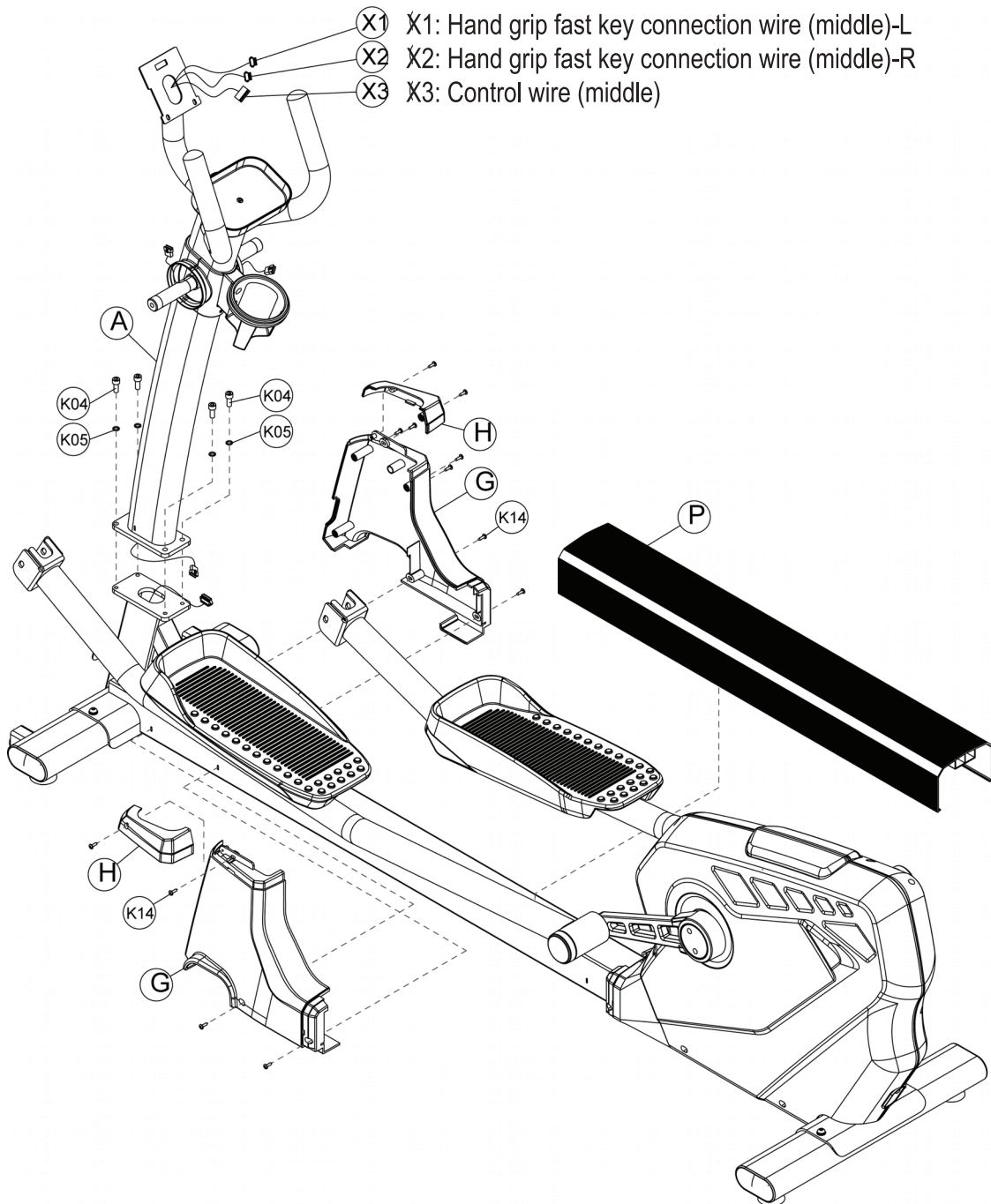

Step 3:

1. Plug into the wave washer (K06) abiding by the image, and then plug the left and right handle set (E, F) into the iron heart of the control tube set, and fasten with the screw (K07) and washer (K08, K09) .

2. After locking, process to the next assembly. Connect the lower terminal of the handle set to the end terminal of the interlock shaft of the interlock pedal set, and fasten with the screw (K10) washer (K11) screw nut (K12) abiding by the image.

3. Connect the middle and lower wire of the hand grip fast key connection wire according to the image, and please pay attention to the direction. If the direction is wrong, please do not plug the wires compulsively. After connection, plug the rest wires into the control tube.

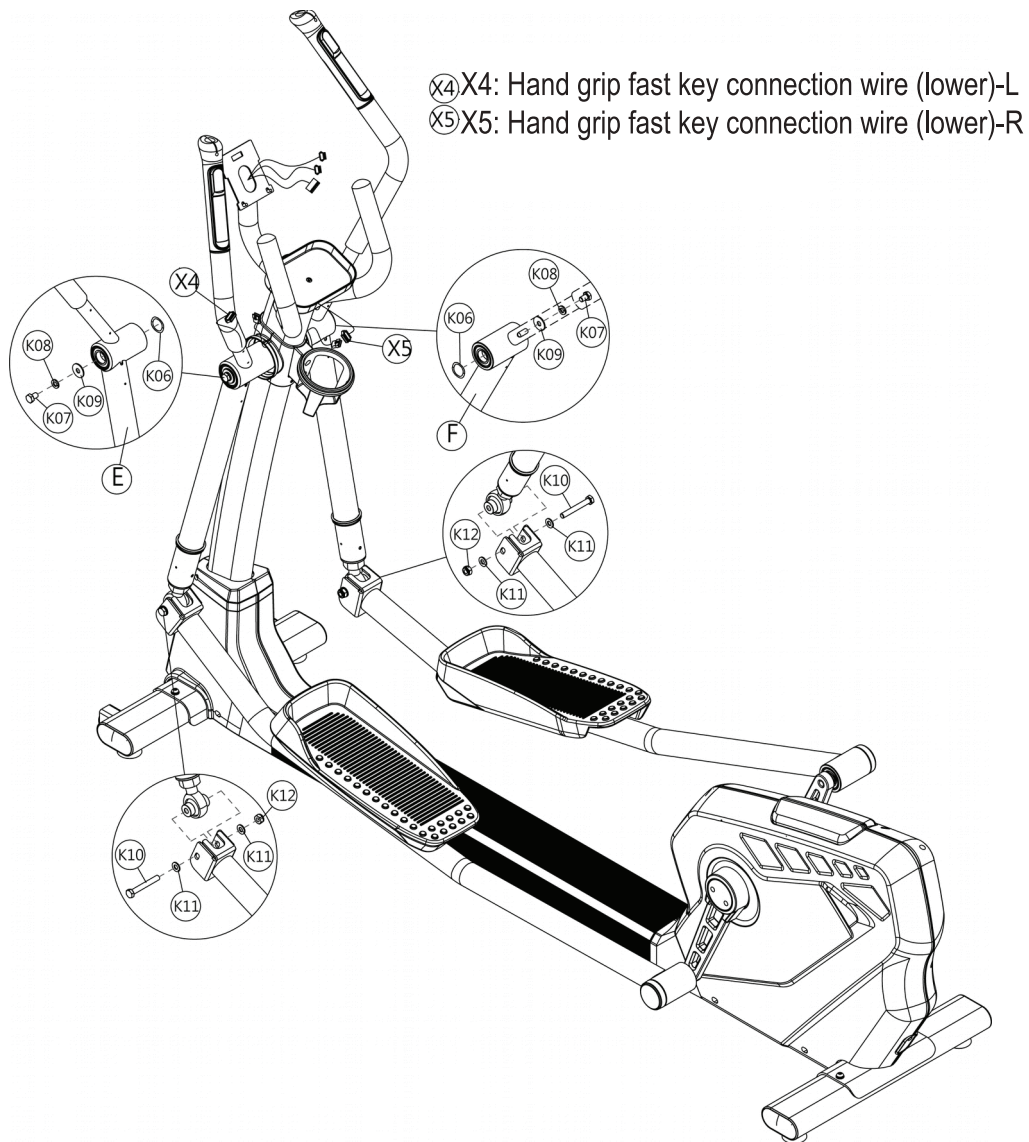

Step 4:

1. Firstly, connect the computer console (J) with the wires of the control tube set, after that, fasten the computer console (J) with screw (K20).
2. Lean the shaft decoration cover set (K, I) to the horizontal of the handle tube set tightly and fasten with screw (K13).
3. Lean the swing tube lower decoration cover (L, M) to the swing tube tightly, and fasten with screw (K13, K14).

Attention:

☒ During the lock of the rubber cover, please check whether the rubber cover match, and whether there is intense connection between rubber covers.

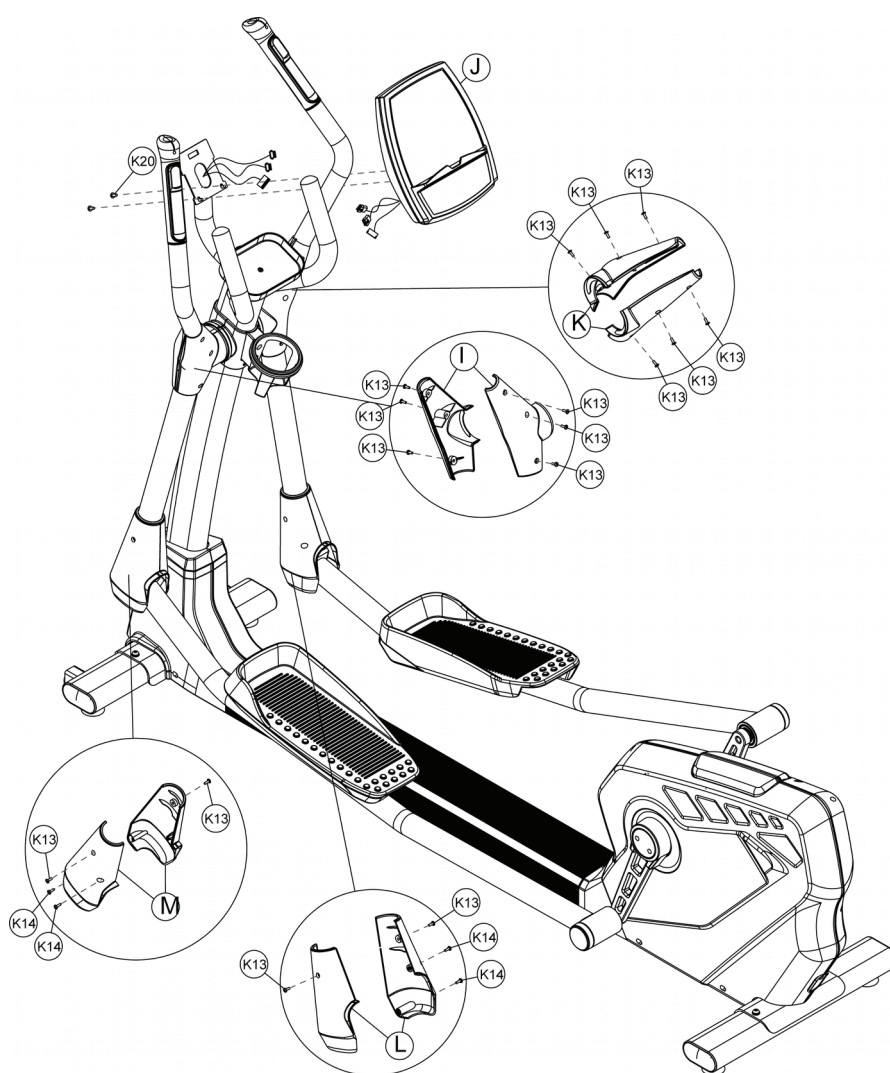

Console Operation Instruction

Window Instructions

This computer is LED window, including RPM、SPEED、TIME、CALORIES、DISTANCE、WATTS、LEVEL and PROGRAM figure Dot matrix display.



Display and start of boot-strap window

1. Start/Ready mode:

When computer lighted up, Dot matrix will show metric(British), code name "KM(ML)"; After this, windows will show the picture of "U1", total U1~U4 for selecting

2. Sleep Mode:

Under start/ready status, if RPM is under 40 more than 15 seconds, enter into 16 seconds prompt mode, (Enter into sleep mode after bi 16 times.) If RPM is more than 40 or press any key in 16 seconds, it will return to start/ready status.

After setup (user setup, weight setup, program setup) 10 seconds, if RPM is not more than 40, computer will return to start/ready status. After 5 seconds, if RPM is not more than 40 or press any key, computer will enter into 16 seconds prompt mode, (Enter into sleep mode after bi 16 times.). If RPM is more than 40 or press any key in 16 seconds, it will return to start/ready status.

3. Under all modes, if RPM is not more than 40, Dot matrix will display "RPM↑" and enter into "PAUSE" mode after 5 seconds.

※ Under HRC mode, it is 70~80RPM

Key instruction

1. START:

Under start/ready status, press start key, computer will begin to work under quick start.

2. STOP/REST :

When computer is working, you can press stop/rest to pause.

When setup the mode under program, you can press this key return to the program and setup the mode.

3. UP/DOWN :

Do select mode, adjust value. When computer is working, increase or decrease resistance.

4. ENTER/MODE :

Press this key into data setting and confirm setting or modified values.

5. RECOVERY :

After exercising for a period of time, keep holding on handgrip until "PULSE" displays heart rate, press "RECOVERY" button, then holding on handrail for 60 seconds.All function display will stop except "TIME" starts counting down from 00:60 to 00:00.

Screen will display your heart rate recovery status with the F1,F2....to F6.Press the RECOVERY button again to return the main display.) F1 is the best.

6. P1~P12 PROGRAM quick key:

On computer, there are separate keys for P1~P12 program. Press the key into the program mode directly.

Use quick key to set P1~P12 PROGRAM :

1. After start the computer, setting the USER of U1~U4, the value of Weight, then press "MODE / ENTER" key to enter each mode status.
2. When select each mode status, press separate keys for P1~P12 program, enter the program mode directly.
3. After enter it, the method of setting TIME – DISTANCE – CALORIES is same as the above method(3~6).

During workout, press "MODE / ENTER" key to change the display of " SPEED - TIME – DISTANCE / RPM - CALIROES - WATTS "

During workout, press "STOP/REST" key one time to pause the program , the LED window of TIME / DISTANCE / CALORIES will display the workout value. Press "START" key the computer will return to start status and count values of TIME / DISTANCE / CALORIES.

Press "STOP/REST" key first time, if press "STOP/REST" key twice time, delete the workout values and return to program mode, all LED lights of " MANUAL / PROGRAM / USER / HRC / WATTS " are flashes.

Situation during workout and display of Dot matrix:

During workout, When PRM is less than 40 and Dot matrix will display 『RPM↑』 and after 5 seconds, it will enter into pause mode and display pause 5 seconds.

USER mode

1. Press " UP / DOWN " key to select "USER" .
2. Enter "USER" mode.
3. Press "MODE / ENTER" key, the "TIME" LED is light up and flashes, the initial value is"0:00", press " UP / DOWN " key to set "TIME".
4. After setting "TIME", press "MODE / ENTER" key, the "DISTANCE" LED is light up and flashed, the initial value is "0.0", press " UP / DOWN " key to set "DISTANCE" .
5. After setting "DISTANCE" , press "MODE / ENTER" key, the "CALORIES" LED is light up and flashed, the initial value is "0" , press " UP / DOWN " key to set "CALORIES".
6. You can set TIME – DISTANCE – CALORIES repeated. After setting TIME、DISTANCE、CALORIES, press "START" key to run.

Program control function

P1 ~ P12 PROGRAM

1. Press " UP / DOWN " key to select P1~P12 PROGRAM
2. Enter PROGRAM mode to select the operate mode.
3. Press "MODE / ENTER" key, the "TIME" LED is light up and flashes, the initial value is"0:00", press " UP / DOWN " key to set "TIME".
4. After setting "TIME", press "MODE / ENTER" key, the "DISTANCE" LED is light up and flashed, the initial value is "0.0", press " UP / DOWN " key to set "DISTANCE" .
5. After setting "DISTANCE" , press "MODE / ENTER" key, the "CALORIES" LED is light up and flashed, the initial value is "0" , press " UP / DOWN " key to set "CALORIES".
6. You can set TIME – DISTANCE – CALORIES repeated. After setting TIME、DISTANCE、CALORIES, press "START" key to run.

Use quick key to set P1~P12 PROGRAM :

1. After start the computer, setting the USER of U1~U4, the value of Weight, then press "MODE / ENTER" key to enter each mode status.
2. When select each mode status, press separate keys for P1~P12 program, enter the program mode directly.
3. After enter it, the method of setting TIME – DISTANCE – CALORIES is same as the above method(3~6).

During workout, press "MODE / ENTER" key to change the display of " SPEED - TIME – DISTANCE / RPM - CALIROES - WATTS " During workout, press "STOP/REST" key one time to pause the program , the LED window of TIME / DISTANCE / CALORIES will display the workout value. Press "START" key the computer will return to start status and count values of TIME / DISTANCE / CALORIES.

Press "STOP/REST" key first time, if press "STOP/REST" key twice time, delete the workout values and return to program mode, all LED lights of " MANUAL / PROGRAM / USER / HRC / WATTS " are flashes.

Situation during workout and display of Dot matrix :

During workout, When PRM is less than 40 and Dot matrix will display『RPM↑』 and after 5 seconds, it will enter into pause mode and display pause 5 seconds.

WATTS mode :

1. Press " UP / DOWN " key to select WATTS.
2. Enter PROGRAM mode.
3. Press "MODE / ENTER" key, the "WATTS" LED is light up and flashes, the initial value is"120"
4. After setting "WATTS", press "MODE / ENTER" key, the "TIME" LED is light up and flashes, the initial value is"0:00", press " UP / DOWN " key to set "TIME".
5. After setting "TIME", press "MODE / ENTER" key, the "DISTANCE" LED is light up and flashed, the initial value is "0.0", press " UP / DOWN " key to set "DISTANCE" .After setting "DISTANCE" , press "MODE / ENTER" key, the "CALORIES" LED is light up and flashed, the initial value is "0" , press " UP / DOWN " key to set "CALORIES". You can set TIME – DISTANCE – CALORIES repeated. After setting TIME、DISTANCE、 CALORIES, press "START" key to run.

During workout, press "MODE / ENTER" key to change the display of " SPEED - TIME – DISTANCE / RPM - CALIROES - WATTS " .

During workout, press "STOP/REST" key one time to pause the program , the LED window of TIME / DISTANCE / CALORIES will display the workout value. Press "START" key the computer will return to start status and count values of TIME / DISTANCE / CALORIES.

Press "STOP/REST" key first time, if press "STOP/REST" key twice time, delete the workout values and return to program mode, all LED lights of " MANUAL / PROGRAM / USER / HRC / WATTS " are flashes.

Situation during workout and display of Dot matri :

During workout, When PRM is less than 40 and Dot matrix will display『RPM↑』 and after 5 seconds, it will enter into pause mode and display pause 5 seconds.

PROGRAM profile

Manual

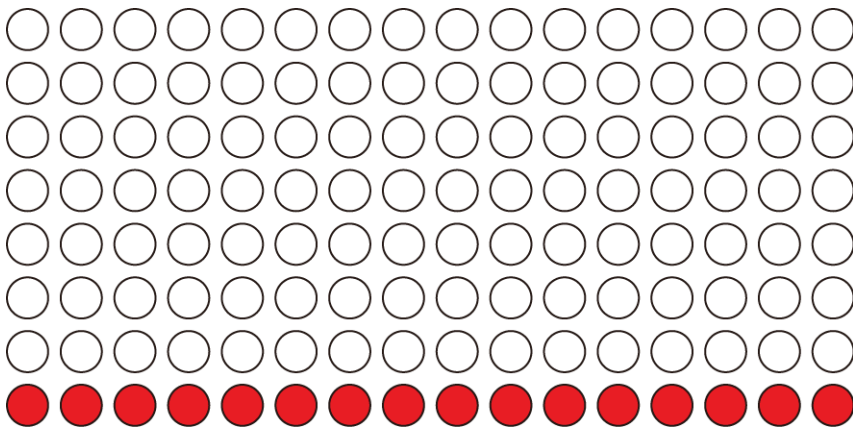

HRC

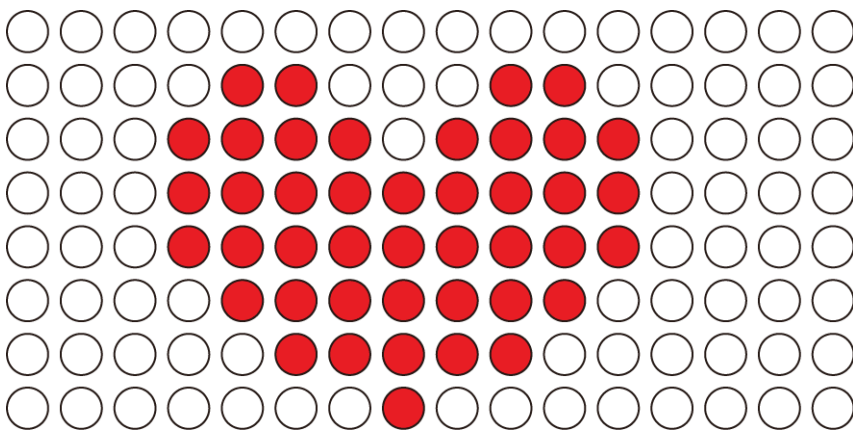

Watts

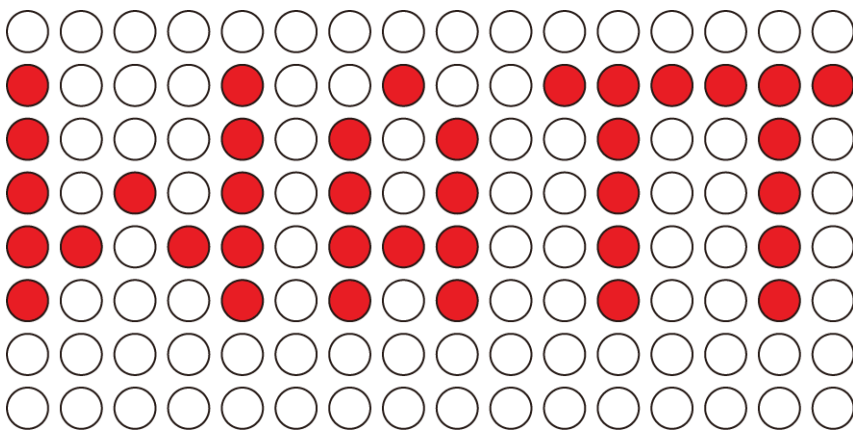

PROGRAM

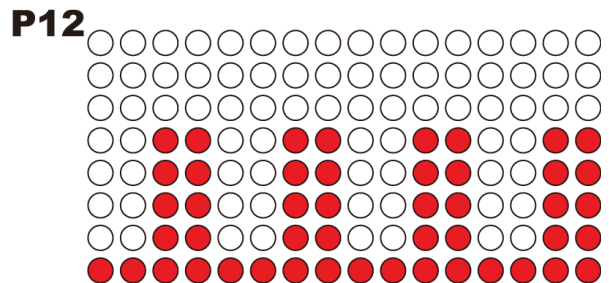
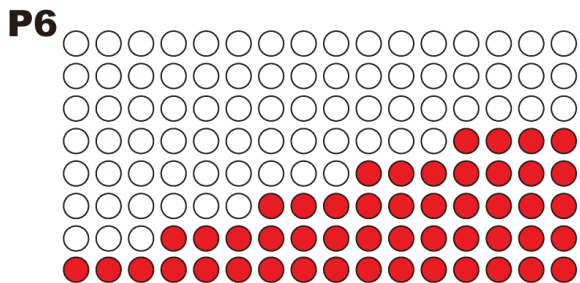
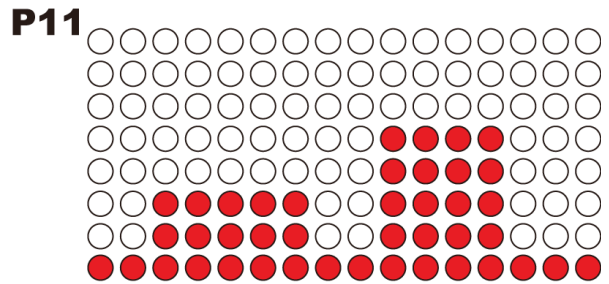
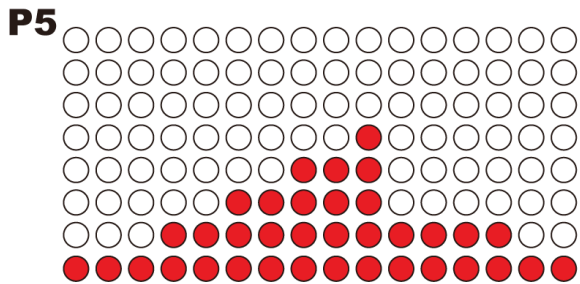
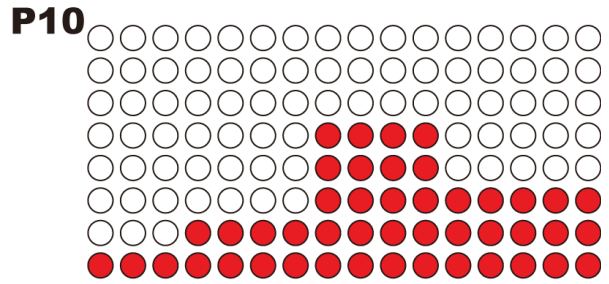
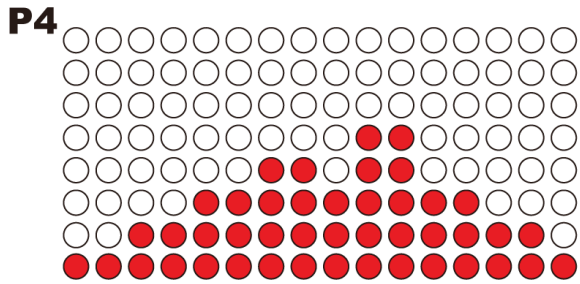
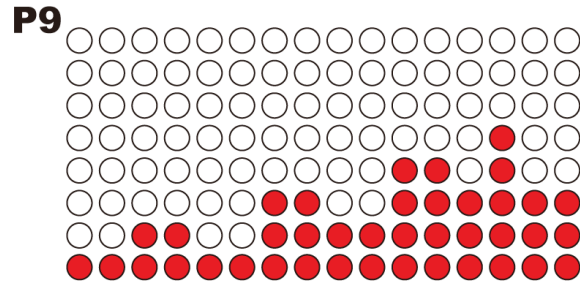
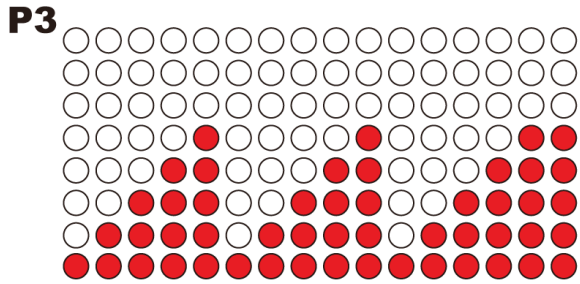
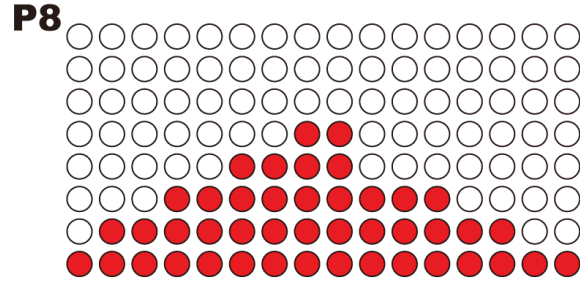
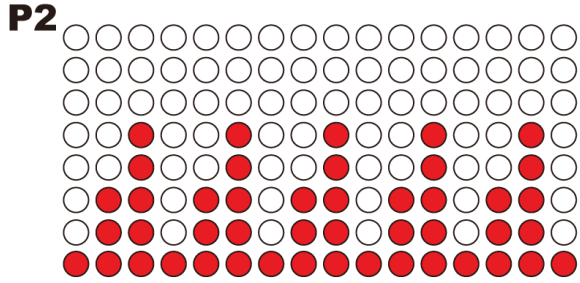
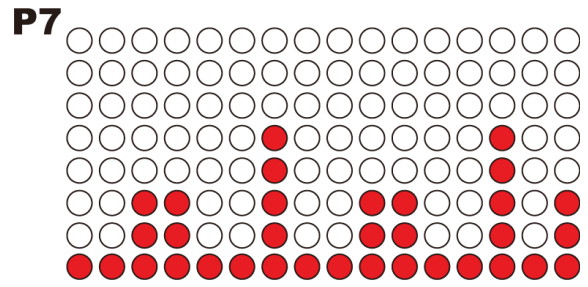
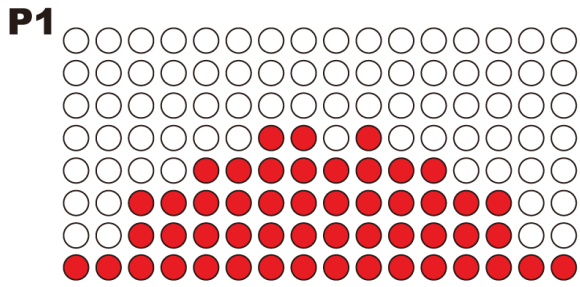



hattrick - pro

T-1000 COMMERCIAL ELLIPTICAL BIKE

**THANK YOU FOR PREFERRING OUR PRODUCT.
WE HOPE YOU ENJOY IT**

This product you have already purchased in under the guarantee of the SPOR DÜNYASI. In case you have any problems with regard to installation or service, please do not hesitate to contact our technical service department by calling 0850 495 52 12.

Please e-mail us at info@spordunyasi.com.tr / teknikservis@spordunyasi.com.tr for all opinions, suggestions and complaints because your opinions are valuable for Spor Dünyası family.

Üretici & İthalatçı Firma Bilgileri (Manufacturer & Importer):

SPOR DÜNYASI Dış. Tic. A.Ş

Mahmutbey Mah. Turgut Cad. No:9 34217 Bağcılar / İSTANBUL

Tel: +90 212 446 94 94 Fax: +90 212 445 27 02

info@spordunyasi.com.tr

www.spordunyasi.com.tr