



**hattrick-pro**

**MS-13**



**Hip Abductor**

**User Manual**

English



## **IMPORTANT DECLARATION:**

First we are highly appreciated that you buy.

For your health and safe, before you exercise please consult from your doctor and define a appreciated exercise burden for yourself. Before using this equipment read carefully all related instructions and notice. In this way you gain more happiness during exercise. When you begin to use, our company think you have read use manual already.

After you buy this equipment, please fill carefully 'post-sale service warranty card' and keep it, meanwhile, post return receipt (stub) back to our company so that we provide better service for you.

This manual is the first edition 2011 of series products. The content of manual will change along with promotion of products, and we will not inform you.

All notice and instruction are in order to keep yoafe and use this equipment correctly. If not obeying the suggestion, take the consequence yourself.

After reading, the user must keep this manual in the place you can see it at anytime.

## WARNING

1. This training equipment is only intended for use in training areas of organizations such as sport associations, educational establishments, hotels, clubs and studios, where access and control is specifically regulated by the owner (person who has the legal responsibility).
2. The training equipment shall only be used in areas where access control is specifically regulated by the owner; the extent of control depends on the users, e.g. degree of reliability, age, experience, etc.
3. The training equipment shall only be used in supervised areas.
4. Always keep unsupervised children and disabled away from the equipment.
5. Injury to health may result from incorrect or excessive training, please consult the coach to choose correct exercise method and proper burden.
6. Please adjust the load and equipment further (e.g. seat adjustment) before using.
7. Please check if the bolt and handrail are out of work before you start to use it.
8. When weight stacks, booms and other parts of this equipment are blocked, must handle with other people's assistance, in case that the weight stacks may suddenly drop and cause accident.
9. Adjust the length of the steel cable properly and never make the steel wire rope twist. After using the machine for a period, the owner shall check the steel cable to make sure no unusual phenomena in connecting. When meet any problems, please consult the professional maintenance personnel at once.
10. Do not suddenly drop the weight stack. In order to avoid destroying other weight stacks, please raise it when the weight stacks nearly collide.
11. While using, forbid hands stretching into the weight stacks or the relative motion parts, so as not to injure the finger.
12. Never allow person with heart disease and children under 12 to use this equipment.
13. The training equipment is in compliance with EN 957-2 class S(S=studio);
14. The max training weight is 150kgs (330pound). The max user's body weight is 150kg (330pound).
15. The machine should be located stably. A space of 2000mm\*2000mm should be around the machine.
16. The scope of products: Primary use in professional fitness club. The second is the residence community, gym of some company
17. If you feel swirl, surfeit and other discomfort sense, Please stop exercising and go for doctor.
18. The equipment should be installed on stable even surface.
19. The machine shall only be used indoor and be avoid of moisture.
20. Wear right shoes and coat
21. Warm up before exercising
22. Don't use the equipment to do the impossible function
23. Please exercise under instruction by professional coach.
24. Inspect if the equipment is fastness before using
25. Any of the adjustment devices that could interfere with the user movement should not be left projecting.

## NOTICE:

1. Warm-up.....It needs warm-up for 5-10 minutes before starting exercise, for instance mark time, free-standing exercises etc., in order to move each joint muscle, so as not to injure the joint muscle while exercising.

2 Diet .....Eat some more protein, vegetables, and fruit. Begin to do exercises until 40 minutes after a meal. Taking food until half an hour after doing exercises and drink little water while doing exercise.

3. Breath.....Breathe in while exerting oneself, exhale while relaxing. To coordinate breathe with movement.

4 Frequency...It needs to take a rest over 48 hours before exercising the same muscle.

5 Burden.....Exerciser should choose suitable weight according to one's own actual conditions, make sure not to be overweight, so as not to cause the muscle to draw wounded. Exercises should according to the progressive principle; it is normal to feel ache while exercise for the first time.

## REGULAR MAINTENANCE

1. The safety level of the equipment can be maintained only if it is examined regularly for damage and wear, e.g. ropes, pulleys, connection points;

2. Pay special attention to components most susceptible to wear.

3. Replace defective components immediately and /or keep the equipment out of use until repair;

4. This equipment should carry on regular maintenance according to the following chart:

MAINTENANCE	EVERYDAY	EVERY WEEK	THREE MONTHS
Check: connecting, bolt, Weight stack bolt	√		
Clearance: cushion and cover	√		
Lubrication: place of sliding			√
Check: bolt if tighten		√	
Lubrication: Bracket of bearing			√

## INSTALL SKETCH MAP

Let assembly become easier

All the content of user's manual is to assured the strength training machine can be installed more easily

Reading the details and instructions before installing:

1. Because the size and weight of equipment is so large, Please choose the installed place near the desired station and assured there is enough space to exercise
2. All parts can be put on the clear area, then backout the wrapper. And the wrapper can't be through away before installation finished.
3. Screw the bolt tightly except the additional instruction
4. All parts must be installed according the illustration indication.
5. Installation work can be finished by tow men
6. Identify all parts by part identify chart

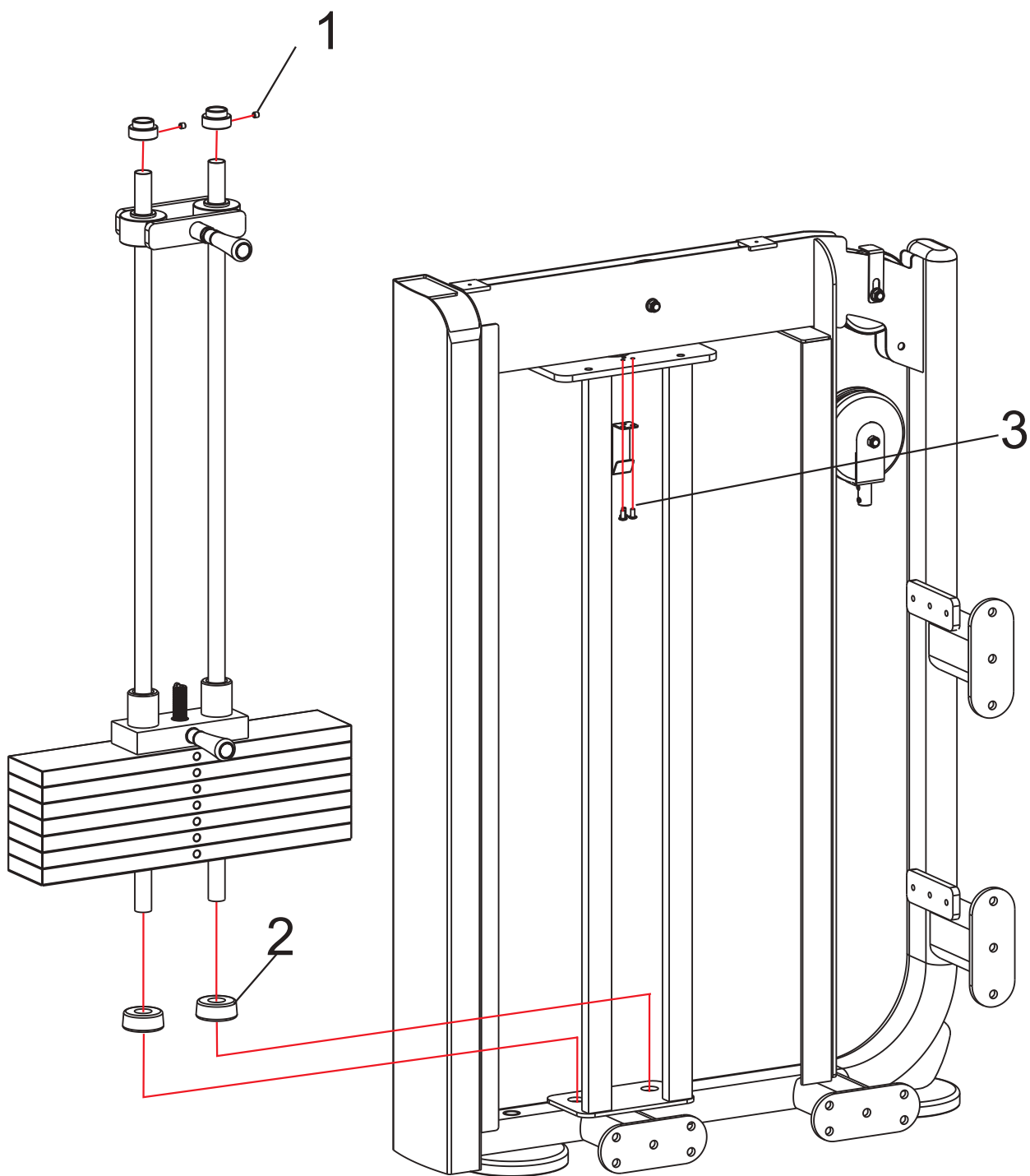

1  X2

M8X10 

2  X2

Φ62xΦ26x25

3  X3

M6X12 

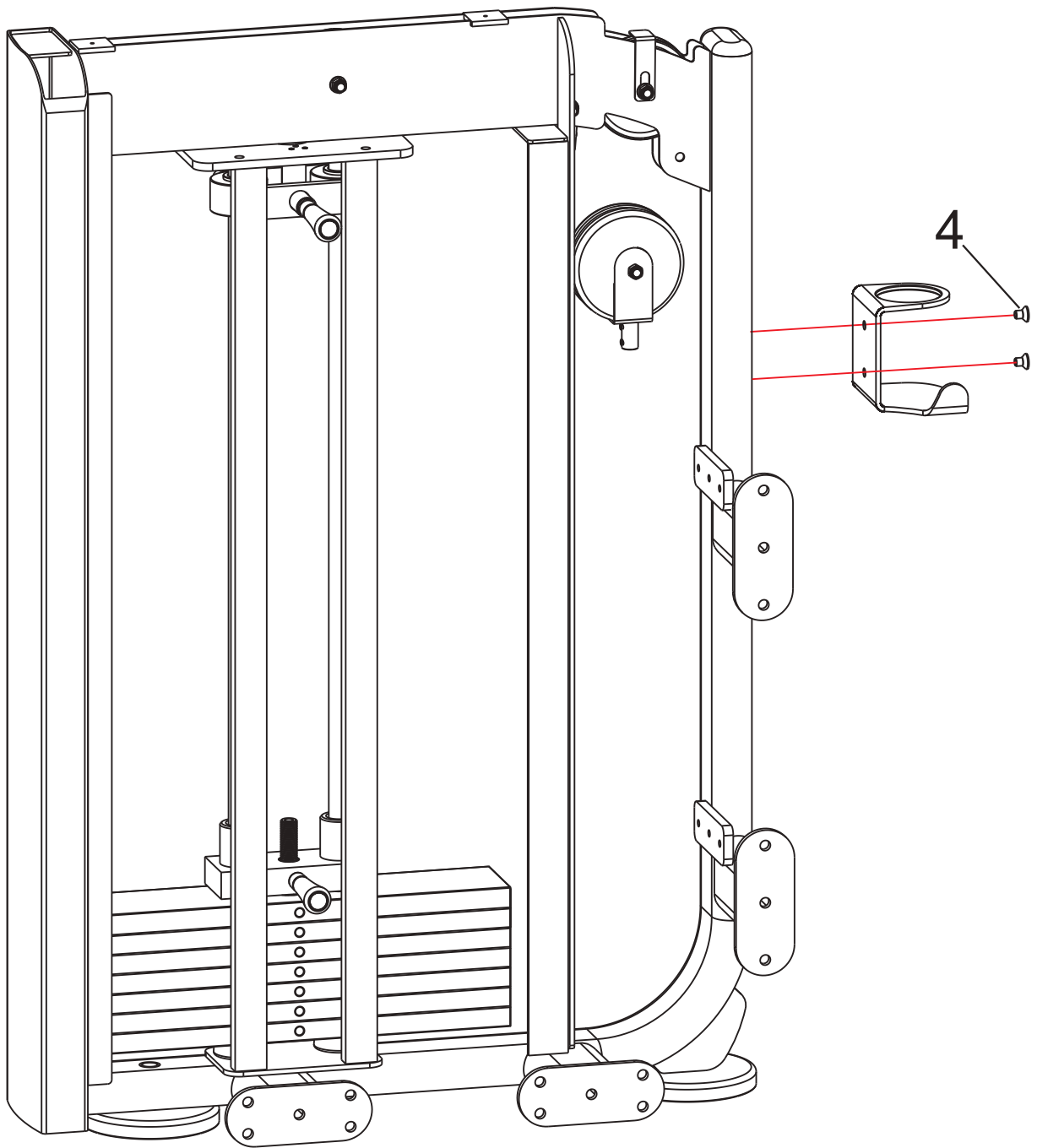







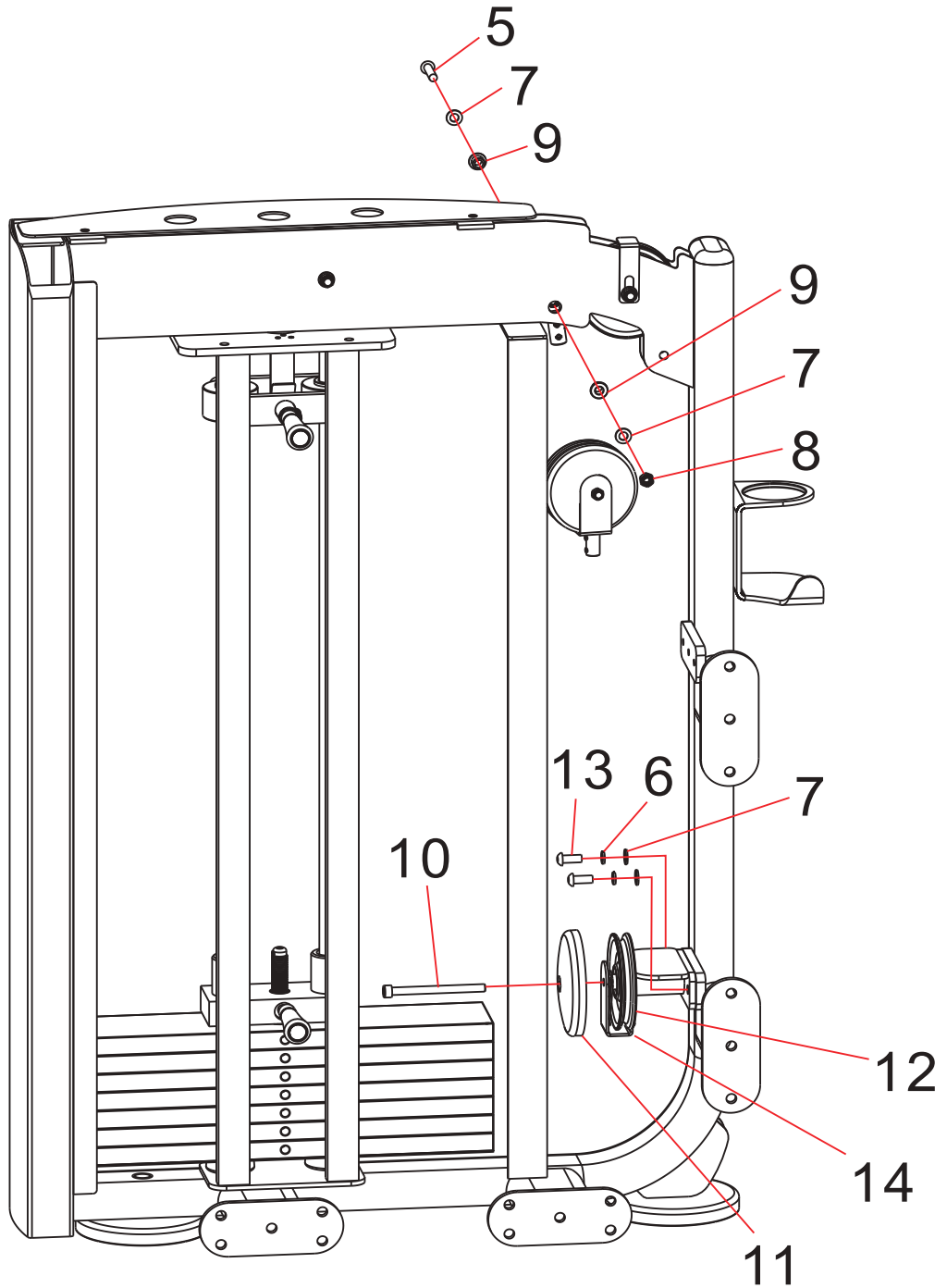

4  X2



M10X20 



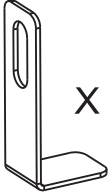

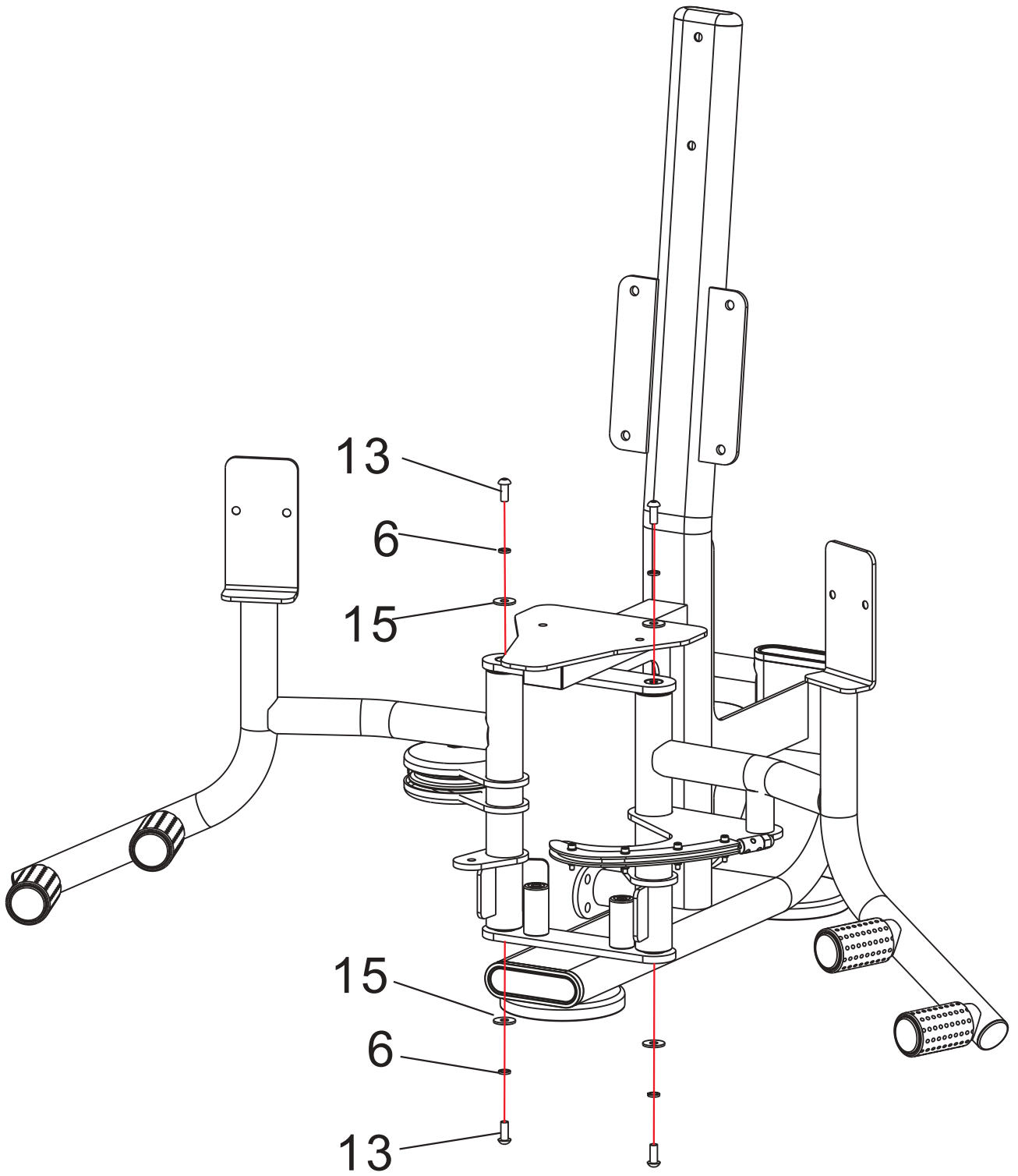



- |  |  |   |   |
|--|--|---|---|
| <p>5  X1<br/>M10X50</p>         | <p>6  X2<br/>M10</p>      | <p>7  X4<br/>M10</p>            | <p>8  X1<br/>M10</p> |
| <p>9  X2<br/>Φ22xΦ10.5x13.5</p> | <p>10  X1<br/>M10X120</p> | <p>11  X1<br/>Φ127</p>         |   |
| <p>12  X1<br/>Φ127</p>          | <p>13  X2<br/>M10X25</p>  | <p>14  X1<br/>(35+80)X25X2</p> |   |

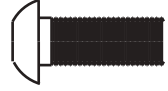



6  X4  
M10 

13  X4  
M10X25 

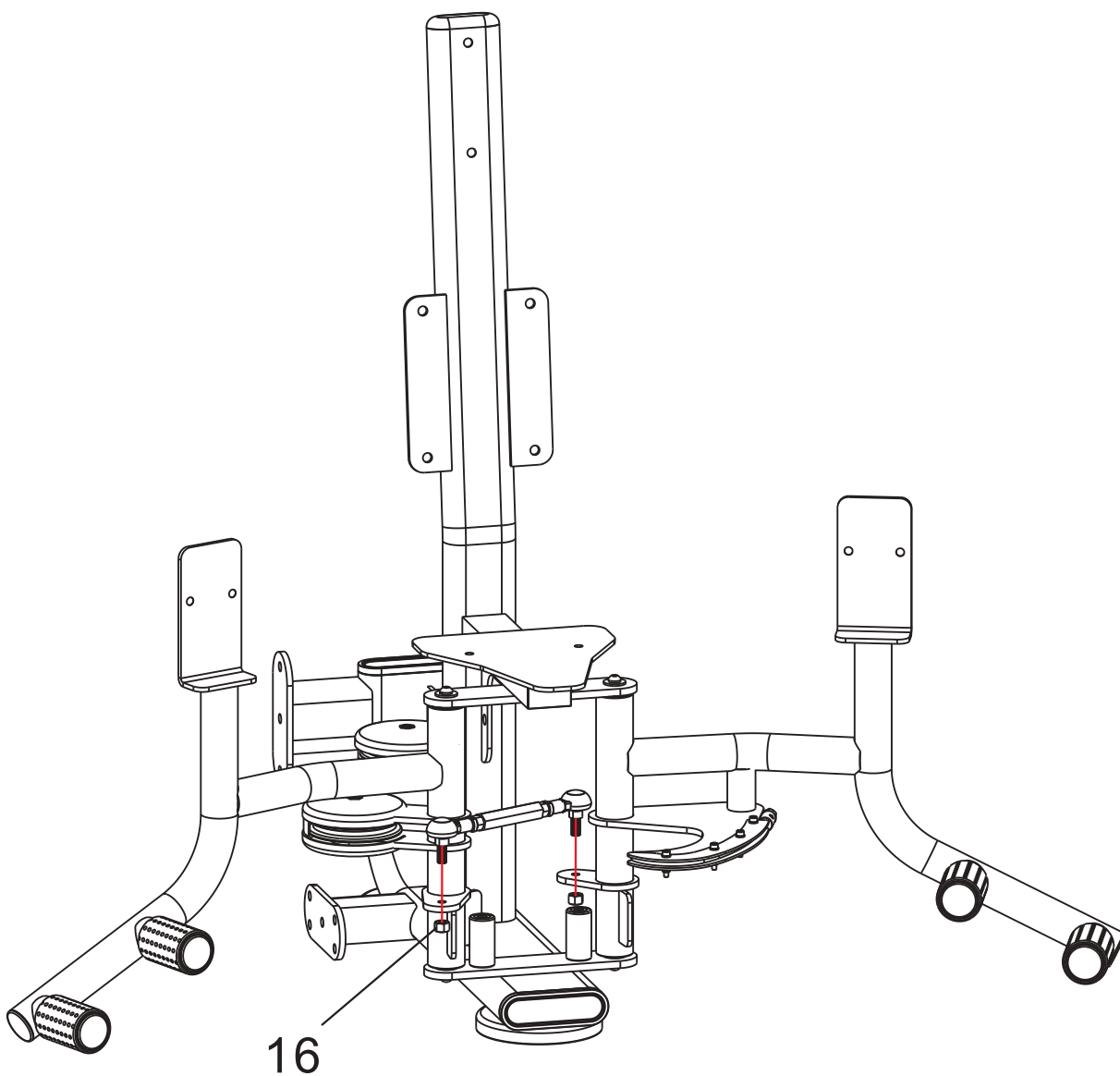
15  X4大  
M10 

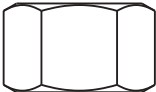

16  X2  
M12X1.25 

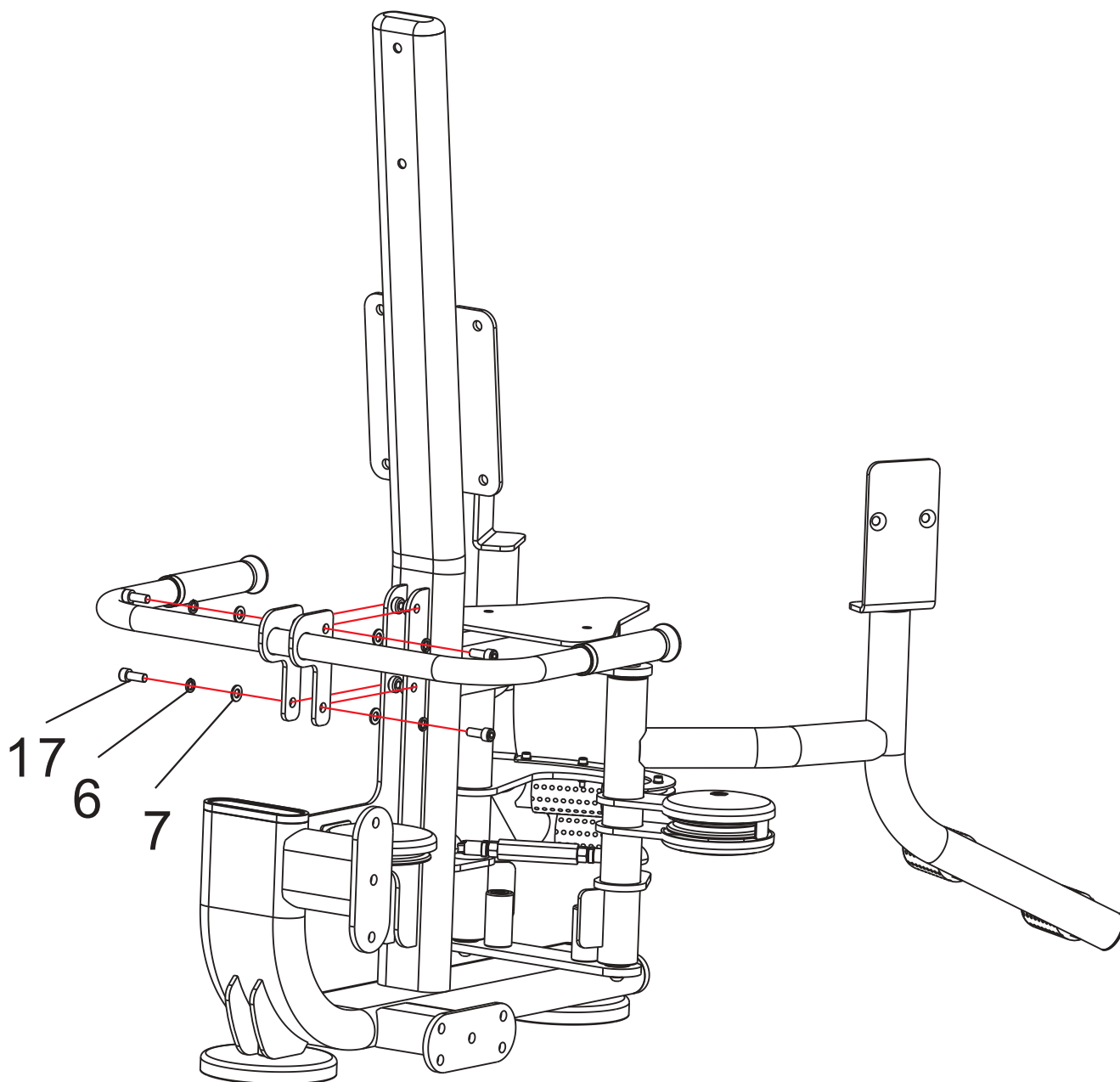

6  X4

M10 

7  X4

M10 

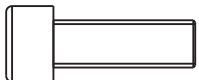
17  X4

M10X25 

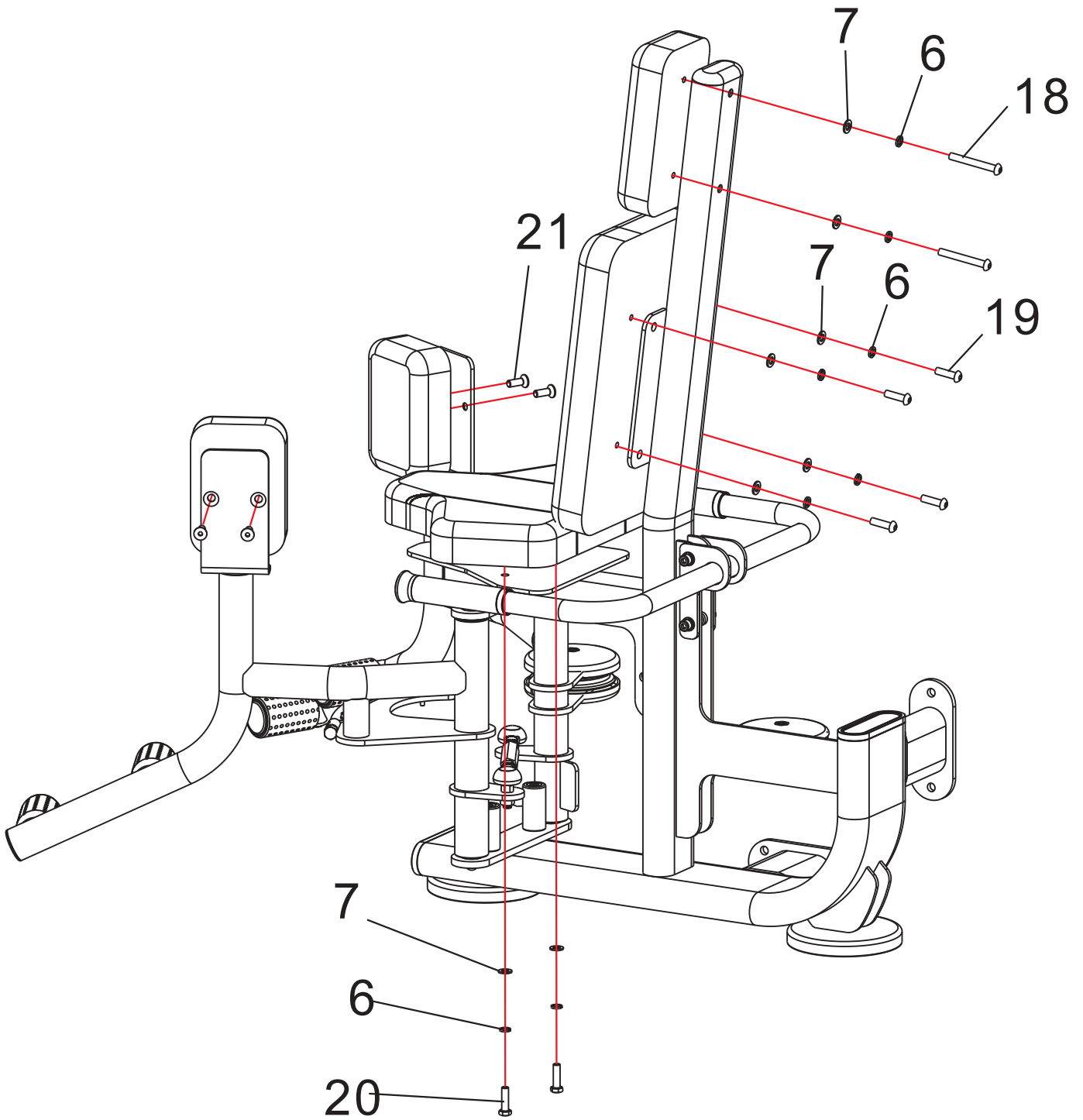

M10 



M10 



M10X80 

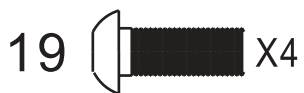

M10X35 

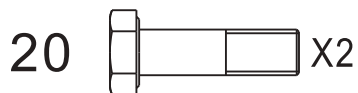



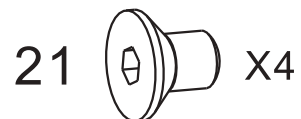

M10X35 

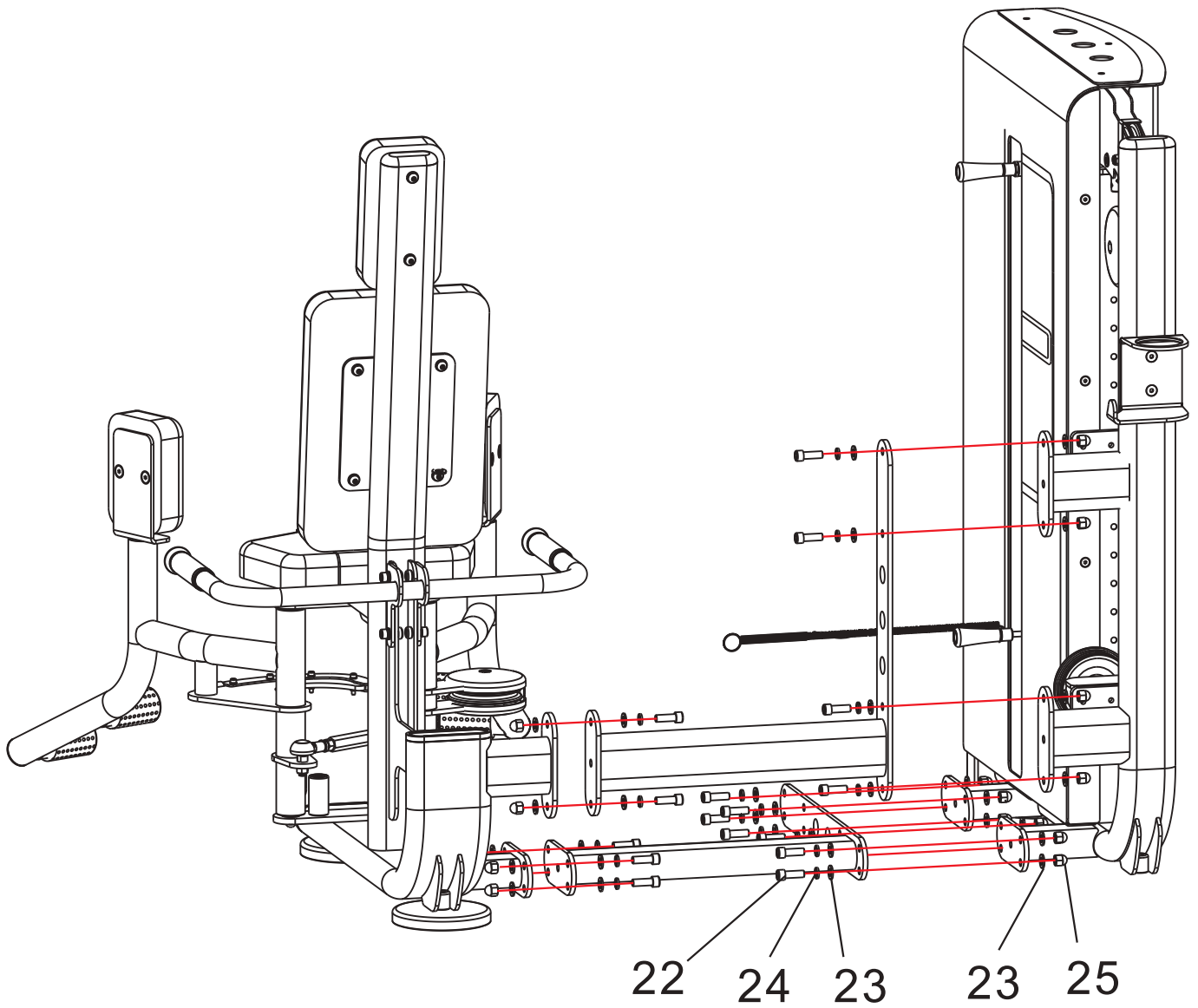

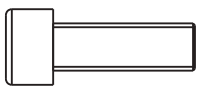



M10X30 



22  X18  
M12X35 

23  X36  
M12 

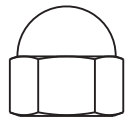

24  X18  
M12 

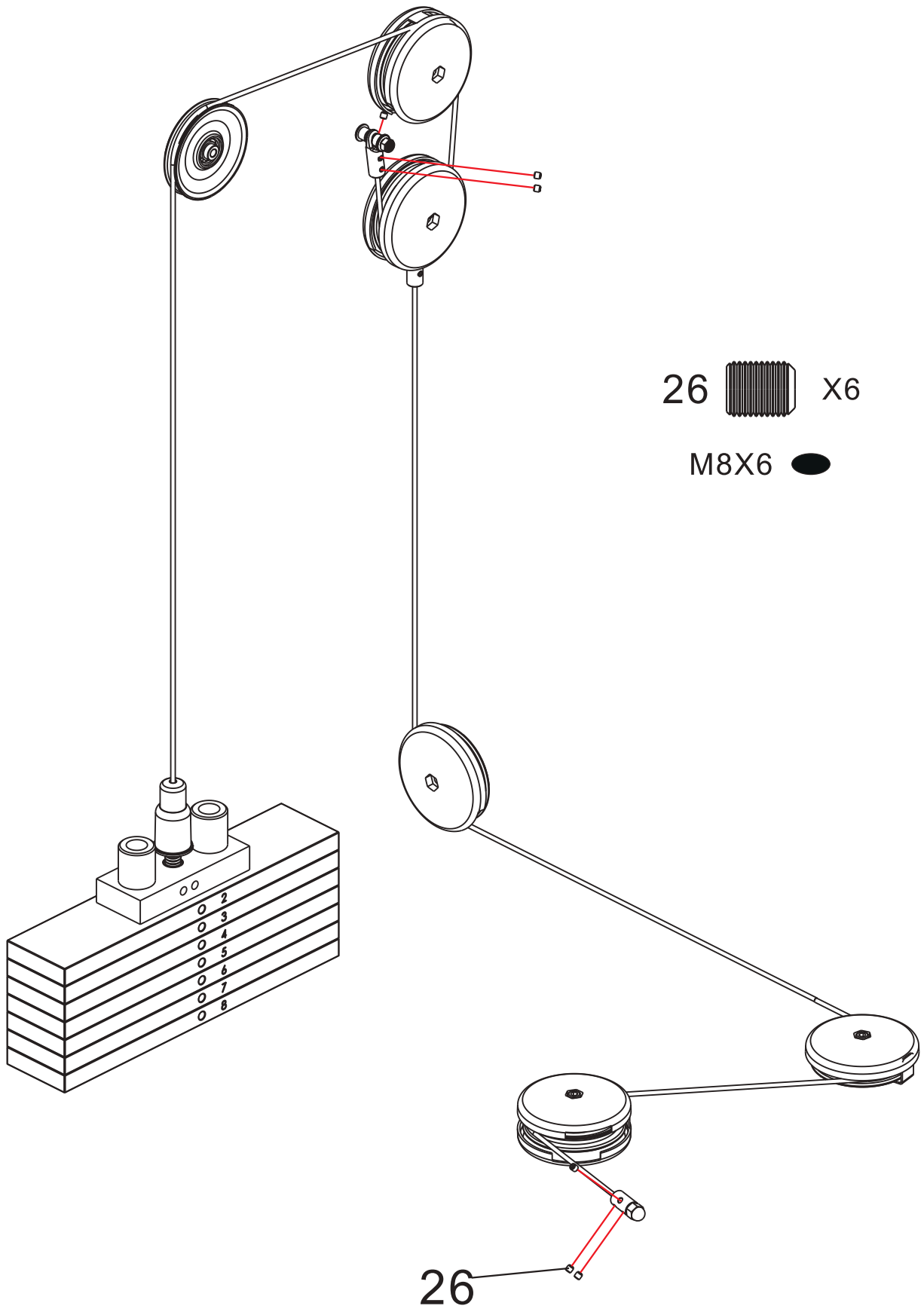

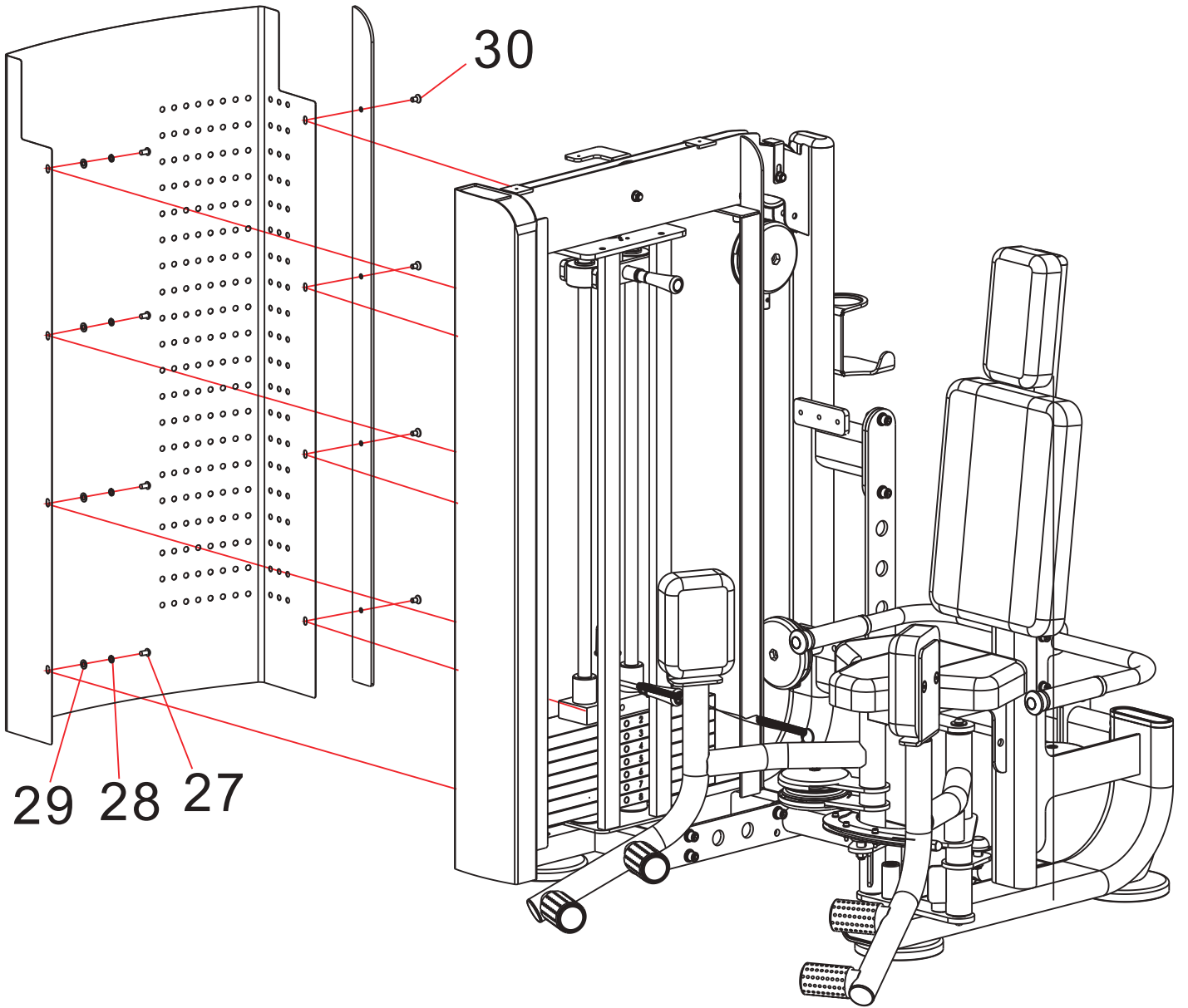
25  X18  
M12 









29 28 27

27  X4  
M8X15 

28  X4  
M8 

29  X4  
M8 





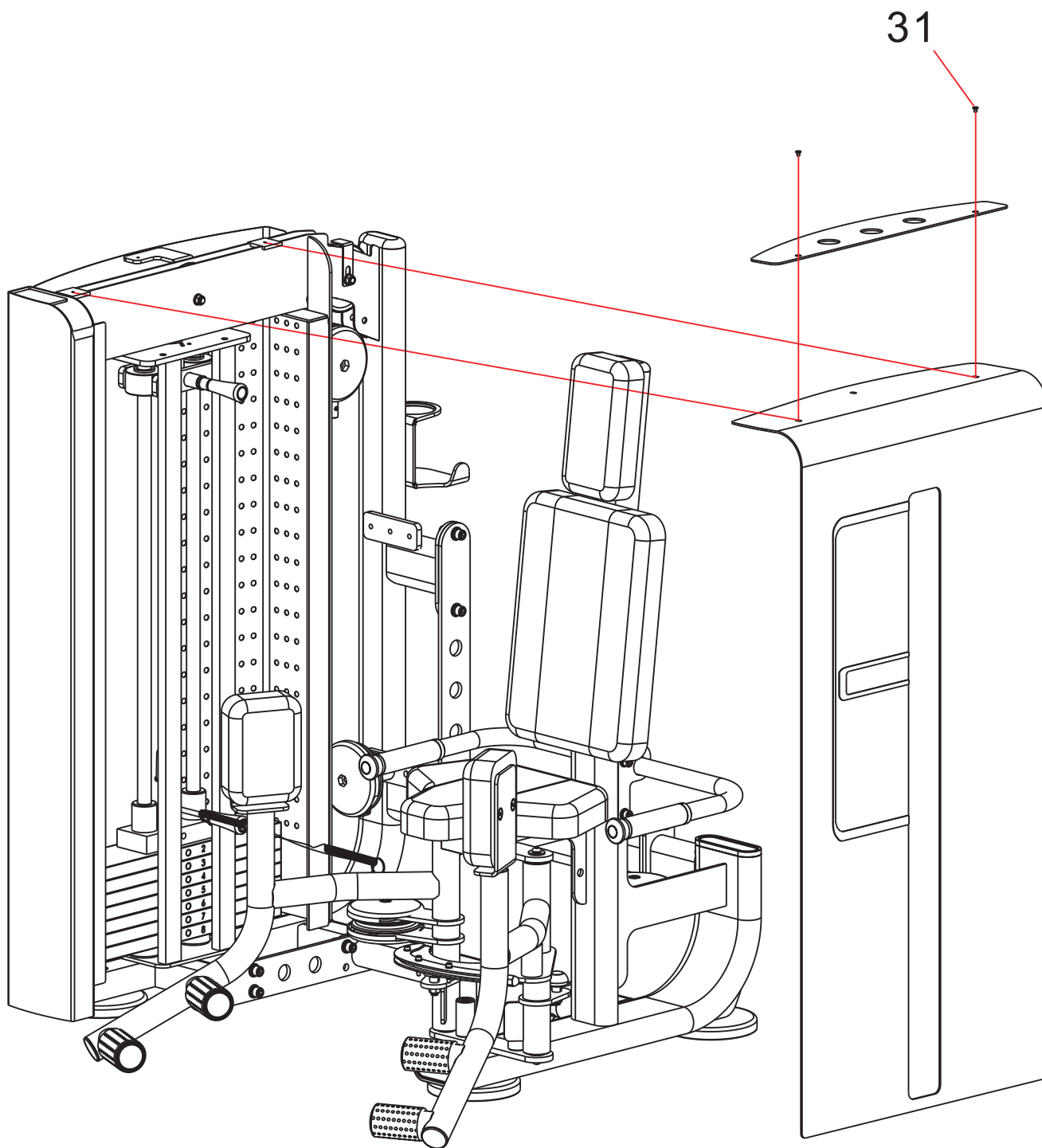

















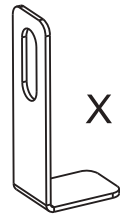

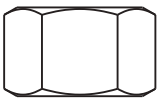
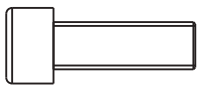
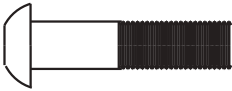
30  X4  
M8X15 

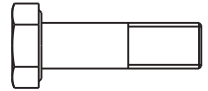
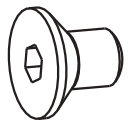
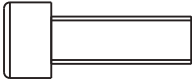

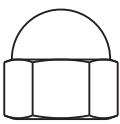

31  X2

M5X10 

- |  |   |  |   |
|--|---|--|---|
| 1  X2<br>M8X10 ●        | 2  X2<br>Φ62xΦ26x25    | 3  X3<br>M6X12 ○      | 4  X2<br>M10X20 ○    |
| 5  X1<br>M10X50 ○       | 6  X18<br>M10 ○        | 7  X16<br>M10 ○       | 8  X1<br>M10 ○       |
| 9  X2<br>Φ22xΦ10.5x13.5 | 10  X1<br>M10X120 ○    | 11  X1<br>Φ127       | 12  X1<br>Φ127       |
| 13  X6<br>M10X25 ○      | 14  X1<br>(35+80)X25X2 | 15  X4大<br>M10 ○      | 16  X2<br>M12X1.25 ● |
| 17  X4<br>M10X25 ○    | 18  X2<br>M10X80 ○   | 19  X4<br>M10X35 ○ | 20  X2<br>M10X35 ○ |
| 21  X4<br>M10X30 ○    | 22  X18<br>M12X35 ○  | 23  X36<br>M12 ○   | 24  X18<br>M12 ○   |
| 25  X18<br>M12 ○      | 26  X6<br>M8X6 ●     | 27  X4<br>M8X15 ○  | 28  X4<br>M8 ○     |
| 29  X4<br>M8 ○        | 30  X4<br>M8X15 ○    | 31  X2<br>M5X10 ○   |   |





# hattrick - pro

## MS-13 HIP ABDUCTOR

**THANK YOU FOR PREFERRING OUR PRODUCT.  
WE HOPE YOU ENJOY IT**

This product you have already purchased in under the guarantee of the SPOR DÜNYASI. In case you have any problems with regard to installation or service, please do not hesitate to contact our technical service department by calling 0850 495 52 12.

Please e-mail us at [info@spordunyasi.com.tr](mailto:info@spordunyasi.com.tr) / [teknikservis@spordunyasi.com.tr](mailto:teknikservis@spordunyasi.com.tr) for all opinions, suggestions and complaints because your opinions are valuable for Spor Dünyası family.

**Üretici & İthalatçı Firma Bilgileri (Manufacturer & Importer):**

SPOR DÜNYASI Diş. Tic. A.Ş

Mahmutbey Mah. Turgut Cad. No:9 34217 Bağcılar / İSTANBUL

Tel: +90 212 446 94 94 Fax: +90 212 445 27 02

[info@spordunyasi.com.tr](mailto:info@spordunyasi.com.tr)

**[www.spordunyasi.com.tr](http://www.spordunyasi.com.tr)**